



# Power Motion *i*- MODEL A

Fast, flexible and reliable



FANUC America Corporation  
[www.fanucamerica.com](http://www.fanucamerica.com)  
888-FANUC-US (888-326-8287)



# Power Motion *i*-MODEL A— The right choice for all general motion applications

Power Motion *i*-MODEL A has been developed for high performance, multi-axes general motion applications. The Power Motion *i* is an integrated solution providing a variety of powerful custom screen development tools, a high-speed, multi-path PMC ladder interface and up to 32 axes/4 paths of high-performance motion control. With specialized functions such as pressure and position control, multi-axes synchronization, electronic CAM and the high-speed response, the Power Motion *i* is the first choice for a wide range of general motion applications. FANUC controls have a world-class reputation for performance, precision, reliability, and user-friendly operation. With more than 2.4 million controls and 12.7-million servo motors installed around the globe, FANUC is the world's leading CNC, motion system and robot manufacturer.





## The first choice for the most demanding applications

The Power Motion *i*-MODEL A is designed for today's most complex, high-performance general motion applications with a large number of axes, multiple part program paths, high-speed ladder functions and highly customizable operator interfaces. The Power Motion *i*-MODEL A supports up to 32 servo axes, 4 simultaneous interpolated axes, 4 programmable paths, 5 independent PMC machine ladders and advanced network connectivity. The Power Motion *i*-MODEL A is ideal for your next general motion project.

- Suitable for a wide range of general motion applications including winding machines, wire saws, gantry loaders, die cushions, presses, multi-axis positioning systems, large robotic table positioning, wing riveting machines and polishing machines.
- Flexible motion control of axes by position, speed, torque or pressure.
- Ideal solution for large servo applications that replace hydraulic mechanisms. Provides high energy efficiency with dynamic power source regeneration and the latest low-loss power devices.
- A broad range of highly customizable display solutions are available to meet application needs including integrated LCD screens, standalone solutions supporting multiple screens and sophisticated hand-held displays that are ideal for teaching or operations close to the application.
- Integrates seamlessly and quickly into production systems with the widest range of field network support. Communications with business systems, manufacturing systems and robots achieved easily with embedded Ethernet
- Integrated safety is available to meet specific industry or European standards.

# A totally integrated motion system



## Single source responsibility

The Power Motion *i* is a highly integrated system with all the displays, high-speed, multi-path PMC ladders, multi-axes motion control including motors and drives manufactured and supported by FANUC to give you peace-of-mind for application development and long-term product support.

## Efficient integration

With all the motion control, PMC ladder logic and even the display integrated into a thin and compact platform, wiring and mounting electrical components are minimized. A fiber optic connection between the control and the servo drives provides guaranteed noise immune data exchange at distances up to 300 feet. A similar fiber optic connection is utilized between the control and the display. I/O Link *i* provides a fast serial interface between the PMC and I/O devices, providing up to 2,048 devices per channel. Digital technology throughout ensures that any data transfer can be performed at high-speed and error-free.

## Flexible OI development

Power Motion *i* supports a wide range of operation interface displays. The application software includes multiple screens ready to run any application. Integrated or external LCD displays are easily customized with FANUC PICTURE. PC-based operators interfaces are available to support Windows-based application development.

## Simplified motion application

In contrast to a PLC-based motion solution, there is very little motion application development. The control of multiple axes or motion are commanded in a simple text-based program. The integrated program editor is simple yet powerful. If the application demands, groups of axes can be programmed independently in paths, with synchronisation points between the paths as required.

## Drive systems

For optimum application performance, FANUC offers a totally integrated range of drives and motors, from traditional rotary and linear servo motors through to very large servo motors. Simple maintenance, high-quality, compact design, exceptional power and efficiency are key factors inherent in their design. General motion applications benefit from FANUC's experience and production volume in machine tool applications - ensuring the highest quality at affordability.

## Integrated PMC/PLC

An integrated, ultra-fast PMC processor controls and monitors the rapid and smooth operation of all machine auxiliary devices. The PMC sequence control offers execution speeds of 9.1 nanoseconds per step for ladder logic programs, and up to five ladders can be executed at the same time.

## Connecting manufacturing with business

Today's ultra-competitive business environment demands flexibility and speed from every aspect of the company. Business speed and customer satisfaction relies on instant access to information that is only possible by connecting manufacturing to business systems, securely and reliably.

The Power Motion *i*-MODEL A meets the challenge with a high-speed Ethernet interface. It supports the industry standard File Transfer Protocol (FTP) for high-speed file transfers. Screens guide the operator to download or upload files to any FTP server directory on a network. The FOCAS 2 interface provides robust, documented access to practically unlimited motion control, machine and process data. Using Drivers and Libraries, applications can be developed quickly with standard development tools.

## Integrating with external systems

The Power Motion *i*-MODEL A supports a wide range of popular field networks including Ethernet/IP, DeviceNet PROFIBUS-DP, FL-net, Modbus/TCP and CC-Link in addition to FANUC's proprietary protocols. Most devices can be connected with a single wire using high-speed, intelligent protocols, reducing integration time and cost.

Integrating the Power Motion *i*-MODEL A with a FANUC robot is simplified by robot interface. Intuitive wizards simplify the application of the I/O interface, grippers, programs and positions. Robot operation and monitoring can be performed through the motion controller screens without entering the safety zones of the robot.

## Open communication at the machine level

As well as FANUC's own integrated I/O structure, alternative fieldbus systems (Ethernet/IP, DeviceNet, Profibus-DP, AS-i, I/O Link II, FL-net, Modbus/TCP and CC-Link) may be connected.

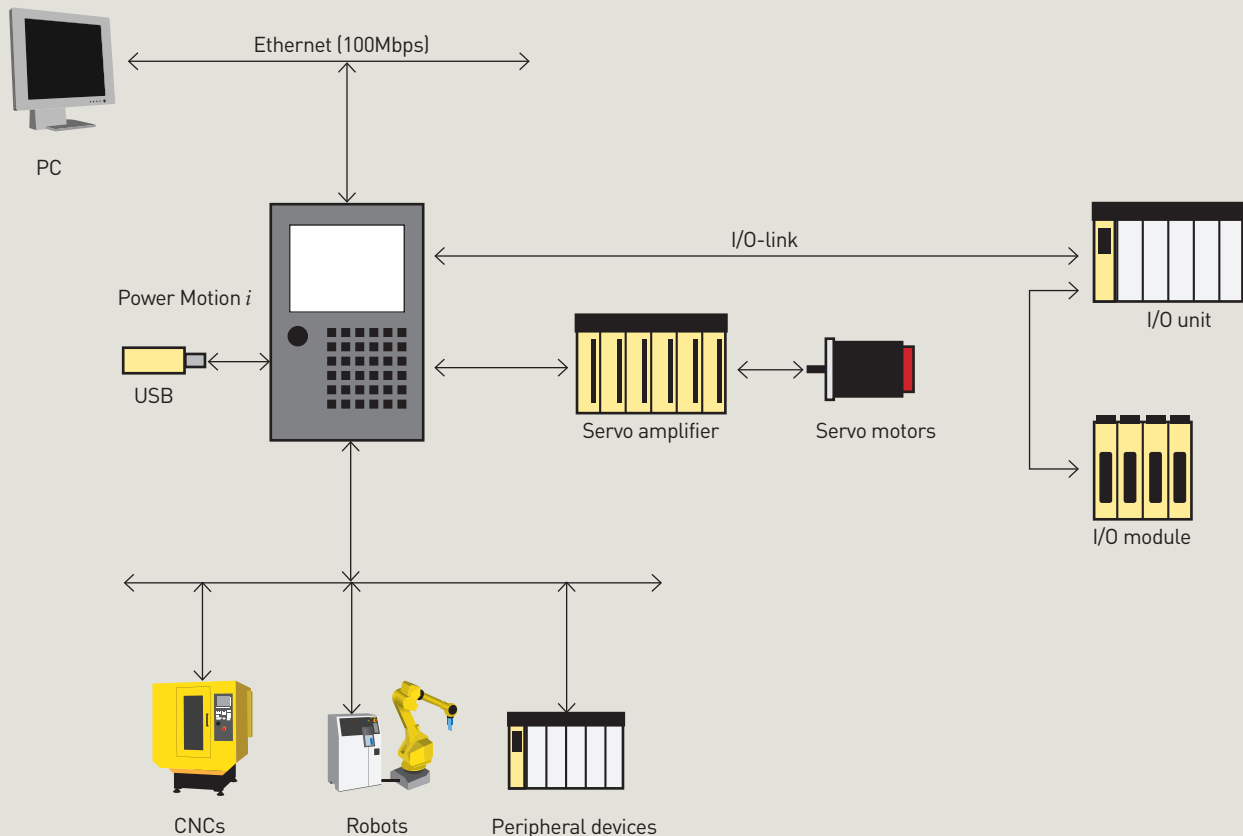

# Flexible operator interface development

The Power Motion *i*-MODEL A has easy yet powerful tools for screen development, providing integrators the flexibility to configure the operator interface to meet their requirements and to add proprietary functionality.

FANUC PICTURE simplifies custom screen development through the use of predefined icons for display components and operator selection buttons. Additionally, advanced functionality can be added with the powerful C-Language-Executer. Custom screens can either replace or complement the standard factory screens. Macros using M and G codes can also be created, providing motion cycles that can be executed at the push of a button.

G4000/5000 WATER LINE

NO MOTION

NO MOTION

	TIP 1	TIP 4	TIP 5	TIP 6
CURRENT WATER LINE LOAD CELL	0 LBS	0 LBS	0 LBS	0 LBS
WATER LINE MOTION NOT ENABLE	TIP 7	TIP 16	TIP 17	
CURRENT WATER LINE LOAD CELL	0 LBS	0 LBS	0 LBS	
WATER LINE POSITION	0.292 IN			
NO MODE SELECTED				

REMOTE OPERATION IS AUTHORIZED

CONTROL ALARM	
MACHINE ALARM	

FANUC PICTURE screen



## PC-integration

At FANUC, the designation 'Open' refers to the combination of a dedicated motion controller and a PC via Ethernet or a high-speed fiber optic interface, which allows transfer of large amounts of data.

**The Power Motion *i*-MODEL A has two 'open' versions:**

- High-performance PC's using Windows® Professional or the diskless Windows® Embedded
- Small footprint operator interface supporting diskless Windows® CE.NET

Both models support the FOCAS2 protocol for the high-speed exchange of data between the motion controller and the PC.

FANUC's Open architecture enables the integration of 3rd-party applications. Open permits the development a wide variety of applications such as custom graphical user interfaces (GUIs) for specialized applications and the exchange of large volumes of data via networks.

## *i*Pendant

The FANUC *i*Pendant is a factory hardened, portable display and operation panel that can be highly customized.

It has multiple applications with Power Motion *i*-MODEL A:

- Complement the primary display on large machines to allow the operator and workstation to get close to the workpiece
- Used as the primary display when the application has simple, temporary or portable display requirements

The FANUC *i*Pendant supports all the standard Power Motion *i* screens for operation, programming and maintenance. A touch panel interface is available and all the keys can be customized with the transparent key sheet.

The unit can switch between MDI (manual data input) mode for data entry and editing and machine operation mode, where the keys are mapped to the PMC ladder.

The connection unit allows the *i*Pendant to be removed for portability or security. It also allows the *i*Pendant to communicate with the motion control system via a standard Ethernet cable. A USB port is located on the rear of the unit.





# Simplified motion applications

## Easy yet powerful motion programming

The Power Motion *i* is primarily a motion control system. That means the basic system is designed to simplify controlling a large number of axes without any application development. The movement of the axes or groups of axes can be controlled synchronously with interpolation or asynchronously with M-codes.

A simple letter-address text file is created to command the motion of the axis. Multiple text files can be created for flex-

ible applications. The Custom Macro feature provides flexibility adding variables and program flow control to the basic programming.

For industries that use machine tools, operators that already have experience with FANUC controls will be comfortable with the Power Motion *i*-MODEL A in no time at all, without the need for expensive retraining.



## Powerful motion program editor

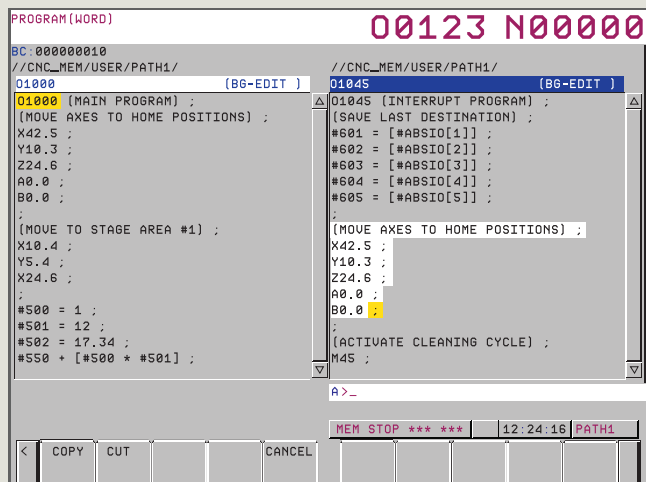

Program and operational consistency is a cornerstone of FANUC's commitment to interoperability. The traditional word editor mode is fully supported and enhanced, whereas the flexible character editing mode may satisfy the needs of a new generation of operators that are used to PC-editors. Character editing mode also makes it easier to quickly modify complex word structures such as Custom Macro statements and program comments.

The background editor allows multiple programs to be displayed side-by-side on the screen and provides the same powerful cut-and-paste and search-and-replace operations as the foreground editor. Background editing mode also allows one part program to be downloaded and modified while another part program is executing in the foreground. Multi-path part programs can also be displayed side-by-side.

## Custom Macro

Custom Macro extends the standard motion programming language to include the features of an easy-to-use, yet powerful computer programming language. Using Custom Macros you can make motion programming more generic and interface with external devices such as trigger probes.

- Variables - local variables for passing parameter values and for intermediate calculations within a macro, common variables shared by all macros, permanent common variables that keep their values even when power is turned off, variables shared between paths and system variables to read and write a variety of CNC data items and generate alarm messages
- Standard operations (add, subtract, multiply and divide)
- Functions - trig (Sin, Cosine, Tangent and their inverse), math (SQRT, ABS, ROUND, FIX, FUP, LN, EXP), logical bit-wise operators (AND, OR, XOR) and conversion (BCD to BIN, BIN to BCD)
- Flow control - branching (IF-THEN and GOTO), conditional Operators (equals, not equals, less than, less than or equal to, greater than, greater than or equal to) and loops (WHILE-DO-END)
- Variety of calling formats with parameters including defining custom G-codes and M-codes
- Output of variable values to serial ports or memory cards

Simply the  
best drives  
available

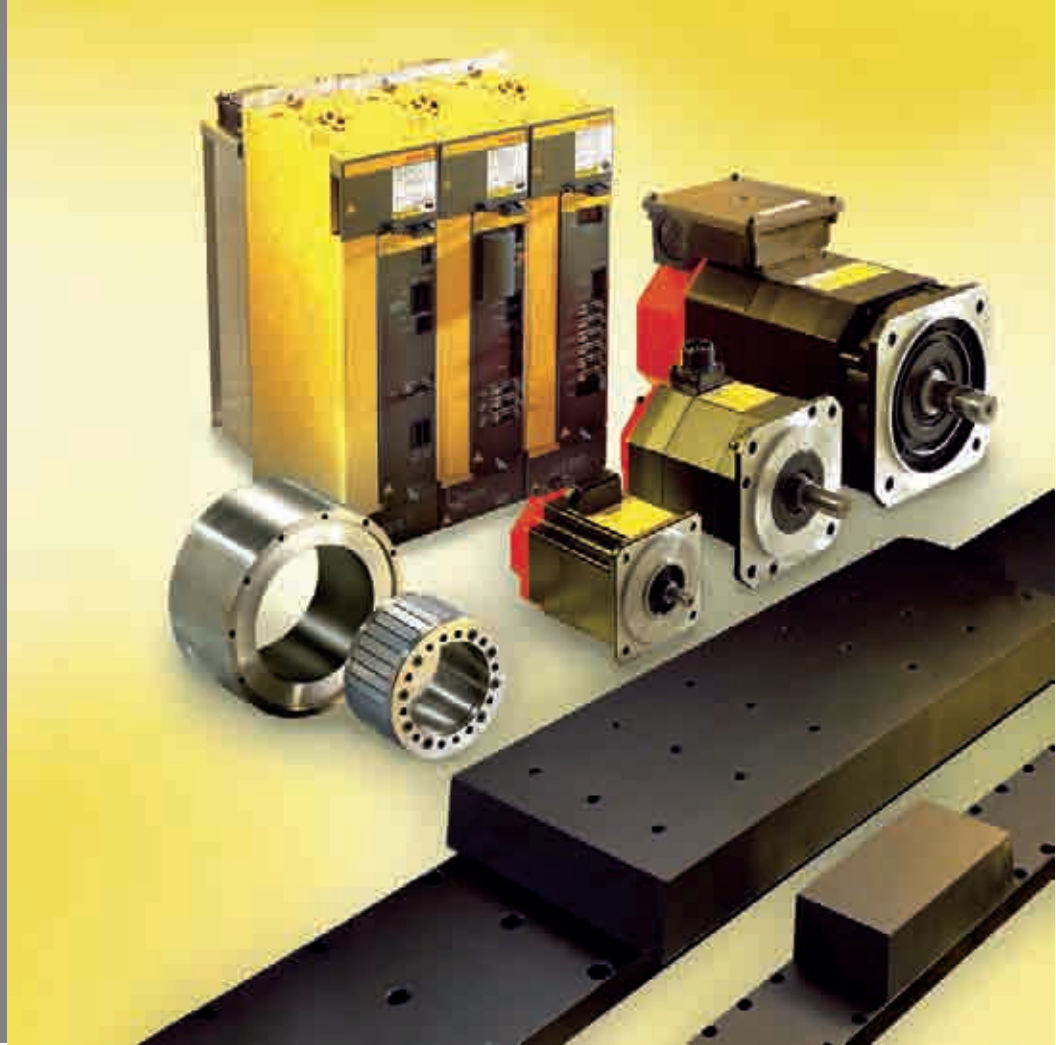

### FANUC AC servo motors

FANUC AC servo motors provide ultra-smooth rotation and quick acceleration

- Wide range of motors with stall torques between 0.16Nm to 3,000Nm ensures there is a motor for practically any application
- Compact size is achieved with an optimized internal structure delivering the smallest motors minimizing machine size
- Intelligent servo motors store all the characteristics of the motor and pulsecoder for quick application and replacement



## FANUC linear motors

FANUC linear motors provide the ultimate in high-speed, high-precision positioning.

- Wide range of motors with stall torques between 300Nm to 17,000Nm ensures there is a motor for practically any application
- High-speed, high acceleration achieve a maximum speed of over 150-inches per second and an acceleration of over 30G, which is difficult to achieve with conventional servo motors
- High-accuracy is achieved using a cooling structure to minimize heat transfer from the motor to the machine



## FANUC servo drives

FANUC servo amplifiers connect to the control system over high-reliability, noise immune fiber optic cables.

- **Compact size:** Optimized cooling design results in smaller amplifiers and electrical cabinet requirements.
- **Energy saving:** Power consumption is reduced significantly with power source regeneration and the use of low power loss devices
- **Technologies for large output:** Larger motors can be applied by using multiple standard amplifiers or tandem control for multiple motors driving a single axis



## Energy saving servo systems

The servo motors in a motion system are continuously accelerating and decelerating as they change speed and direction. When motors are decelerating, their kinetic energy is converted back into electrical energy, which must be dissipated. Low cost drive systems simply burn the energy as heat in a resistive load in a process called dynamic braking.

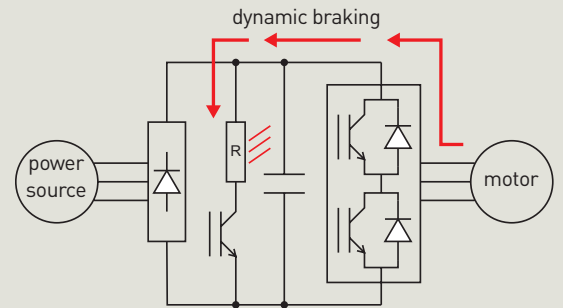

FANUC's state-of-the-art AC drive systems use high-speed, high-efficiency switching circuits to direct the energy back into the main electrical supply, reducing the net energy used. When combined with the more efficient motion processes provided by the Power Motion *i*-MODEL A, electricity costs can be reduced significantly.

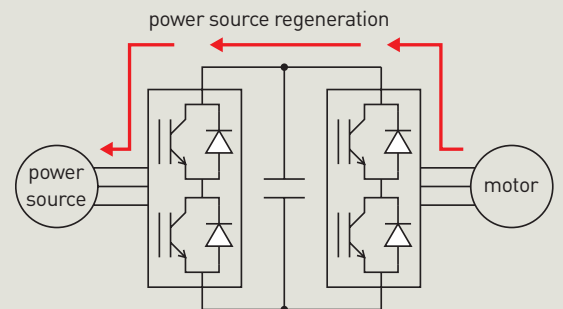

FANUC's motion control systems provide displays that monitor real-time energy usage and savings and allow the data to be collected via Ethernet for analysis.

POWER CONSUMPTION MONITORING			
INSTANTANEOUS VALUE OF POWER			
	-50	0	50 (kW)
X	[Progress bar]		10.095
Y	[Progress bar]		-3.841
Z	[Progress bar]		15.120
B	[Progress bar]		4.798
C	[Progress bar]		-1.309
	-100	0	100 (kW)
S1	[Progress bar]		44.239

# High-speed, multi-path PMC/PLC

The ultra-fast PMC processor provides rapid and smooth operation of all auxiliary devices. The PMC sequence control offers execution speeds of 9.1 nanoseconds per step for ladder logic programs, and up to 5 independent ladders can be executed at the same time. The PMC is fully integrated with windows into the motion control system providing access to a wide variety of data and a robust interface with FANUC Picture for operator interface requirements.

## Scaleable architecture

The integrated PMC can be scaled to suit the application. Up to 5 independent ladders with between 24,000 and 300,000 total steps. Five memory selections provides and increasing number of internal relays, multi-language messages, timers, counters, keep relays and data tables.

The PMC supports ladder logic, step sequence programs and function blocks. The I/O structure supports upto 4,096 inputs and 4,096 outputs.

The ladder can be divided in to 40 subprograms for readability and modular development. It can be displayed and edited on the motion controller screen or with the PC based FANUC Ladder III development tool.

## Nonvolute relay function

The values of the extension relays(E-address) are preserved when the power is removed from the motion controller.

## Multi-path PMC function

Each ladder is executed independently with their own memory address spaces. Paths 1 through 3 can communicate with each other using the shared M and N addresses. The sequence programs and parameters of each PMC path can be updated independent of the other paths.

## Function blocks

Frequently used sections of ladder code can be encapsulated inside function blocks for use in other programs. This object oriented approach improves development and operational efficiency. Once debugged, the contents of the function block can be locked and not displayed.

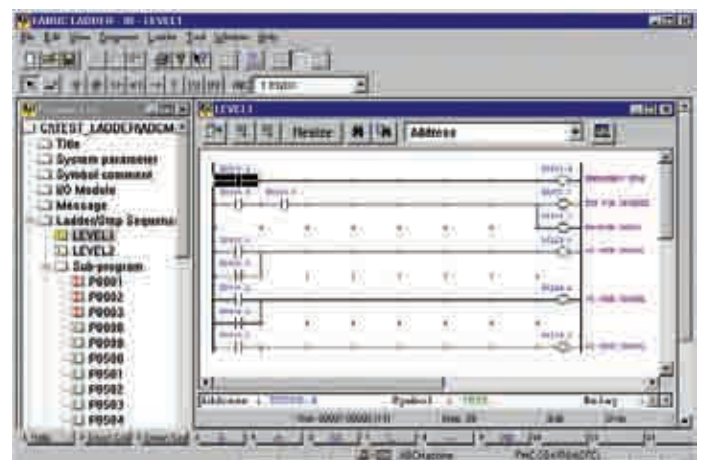
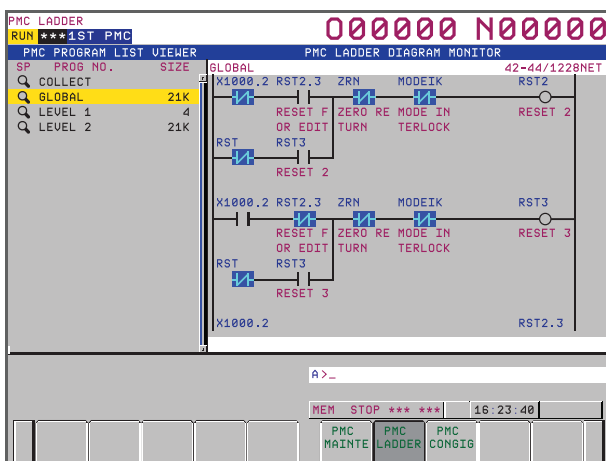

# General industrial machine support

Power Motion *i*-MODEL A provides flexible support of a variety of machine and application configurations. Four programs can be executing at the same time managing up to 32 axes in 4 paths in a single control. Coordination between two or more programs is achieved with synchronizing M-codes. Independent functions such as press operation or material handling can also be coordinated by the program.

## High-response motion control

The Power Motion *i*-MODEL A can respond quickly to external signals, ensuring the accuracy of applications such as stamping, marking, cutting, packaging and wrapping machines.

Independent motion of each axis is achieved by executing multiple programs at the same time within a path. Programs compiled in advance can start program execution earlier. High-response and a short cycle time is achieved with high-speed execution of the PMC ladder.

## Torque control for constant tension

Using torque control of PMC axes, feed-out and winding axes can be controlled independently to maintain a constant tension of sheet material.

## PMC axis controlled acc/dec

PMC axis control provides full control over acceleration and deceleration for each move, optimizing performance.

### Winding machine

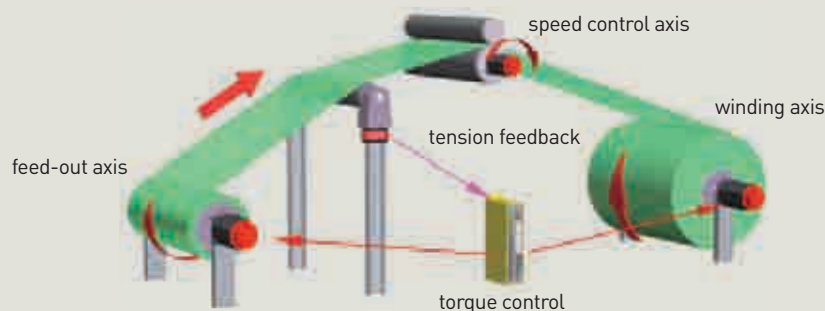

### Stamping machine

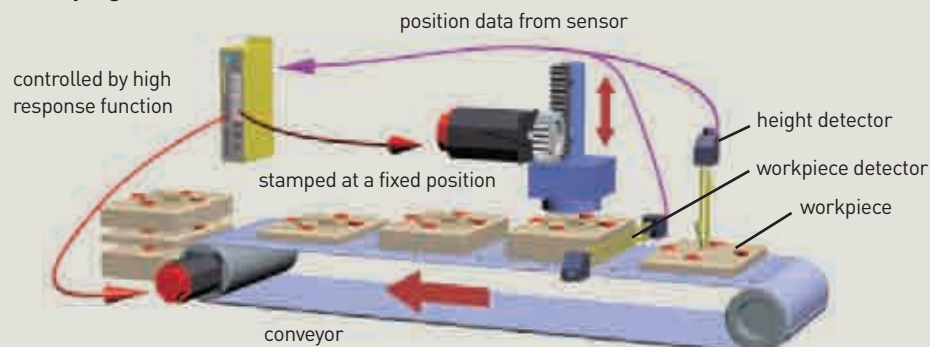

# Extreme reliability - maintenance friendly



## Unmatched reliability

Downtime on your CNC machine is very expensive, especially when you add up the cost of repairs, the lost production capacity, and the potential revenue and goodwill lost if you miss customers' deliveries. FANUC's continuous improvement culture ensures that our CNC systems are the most reliable available. Statistically, a hardware fault occurs only once for every 17 years of productive service.

With the commitment of 25-year replacement part availability and support,\* convenient local parts inventories and economical repair and return services, you can look forward to decades of trouble-free operation with the confidence that your machines will be available for production when you need it.

## Crash protection

Unexpected torque disturbance control allows torque limits to be set so that the axis will stop or retract when a collision is detected, reducing damage to the machine.

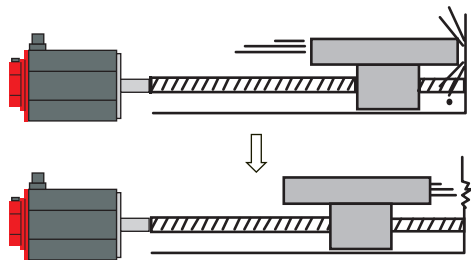

\*When a FANUC CNC system is out of production, we strive to have replacement parts for 25 years. Replacement parts are available for purchase or through extended service contracts. If and when parts are no longer available due to discontinued component manufacturing, we offer repair and reuse. We strive to engineer replacement parts with the same functionality, form and fit. We offer on-site FANUC factory-trained service and support on FANUC CNCs for the lifetime of your machine.

## Prevention of operational errors

Unintentional mistakes can be reduced by requiring operators to confirm things such as deleting motion programs and starting motion programs in the middle. Limits can be placed on the values entered in a variety of screens to prevent crashes due to simple data entry errors.

## Periodic maintenance screens

Motion control and machine component life can be tracked according to a schedules such as power on time and axis moving time. When the actual usage exceed the scheduled maintenance period, the operator is alerted.

## Troubleshooting guidance

Screens lead maintenance technicians easily through recommended procedures to identify the root cause of problems. Integrators can add their own guidance screens.

## Free over the phone support

Field experienced experts are always available to provide you with free over-the-phone technical support and local on-site service whenever you need it.

## Maintenance friendly

Batteries and fans are modularized for quick and easy replacement without tools. A comprehensive package of maintenance tools is integrated into the Power Motion *i* to help keep your application running and making production. A snapshot of any screen can be captured to a memory card to be used in troubleshooting.

## Alarm and operation history

To assist in troubleshooting, a history of keys pressed, PMC signals and alarms are recorded automatically and can be displayed. When an alarm occurs, additional data such as modal information and axis position data may also be recorded and displayed.

## Built-in backup

The Power Motion *i* guarantees minimum downtime due to lost system integrator and user files because important data can be backed up regularly into flash memory. Time can be saved when experimenting and troubleshooting by saving a snapshot of all the existing user files and settings before modifications are made.

## Automatic servo tuning

Recommended servo tuning parameters can be determined quickly and automatically by simply pressing a softkey on a screen built into the motion control, eliminating the need for costly specialized resources. If higher precision is required, optimum velocity gain for each servo axis can be adjusted automatically using the more advanced Parameter Tuning of Velocity Gain tool. Parameters for optimum spindle orientation and high-speed tapping performance are also established effortlessly.

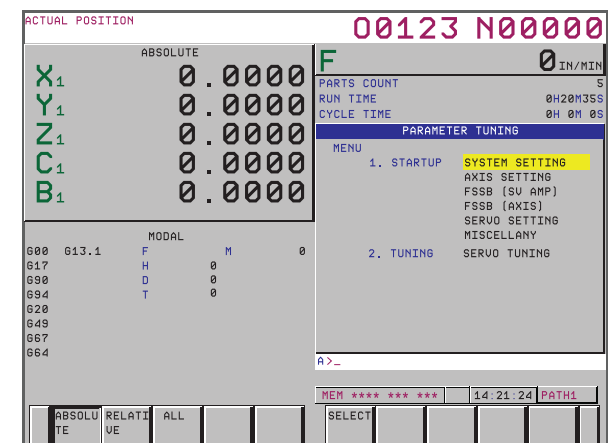
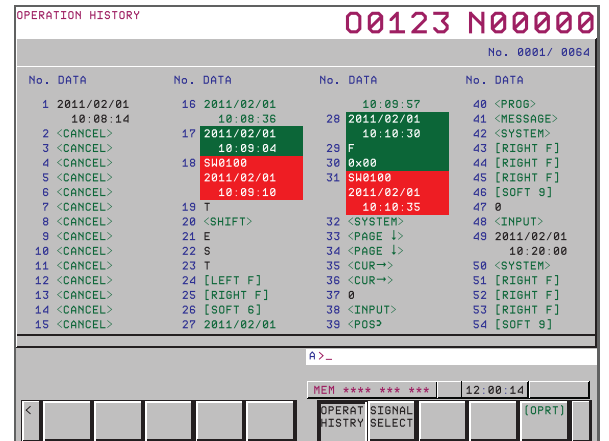
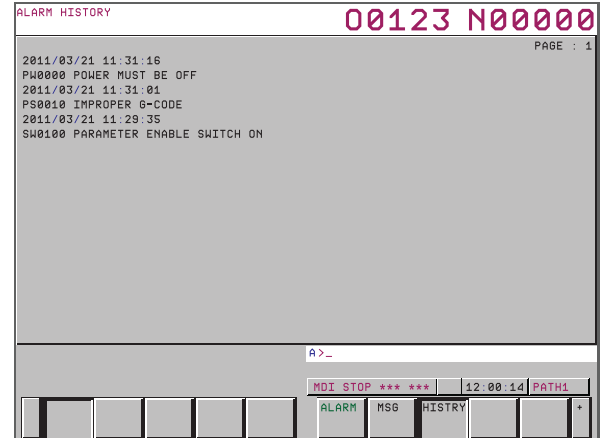

# Virtual MDI Screen Option for Power Motion *i*-MODEL A

The virtual MDI screen is ideal for very high production (automotive) or general motion applications with very little data entry or editing at the machine. Custom screens can be provided by your MTB using FANUC Picture, Macro Executor or C-Executor. Virtual MDI display is used with Touch LCD Display. The normal MDI keyboard is replaced by virtual keyboard on the display screen. The virtual keyboard uses touch screen when MDI functions are needed.

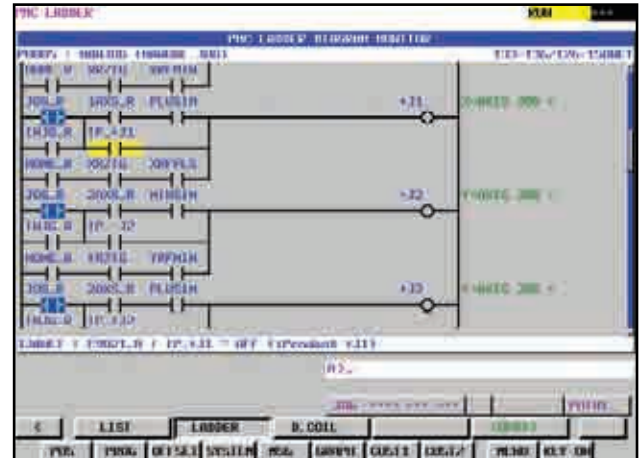

## Exclusive Options for the Power Motion *i*-MODEL A

- **Multi-axes High Speed Response Function (A02B-0334-R396)**  
Part programs compiled beforehand can be executed in high response mode, enabling faster control of axes than normal mode. Up to 24 programs can be executed simultaneously. Up to 24 axes are specified on one path.
- **Macro for Multi-axes High Speed Response Function (-R397)**  
Enables use of macro statements and macro system variables in the multi-axes high speed response motion program.
- **Skip function for Multi-axes High Speed Response Function (-R398)**  
Provides multi-stage skip function for use with multi-axes high speed response function. Up to 24 skip signals can be used.
- **Position Definition Type Synchronous Function (-R399)**  
Allows for slave axis to be synchronized with master axis in multi-axes high speed response function.
- **Pressure and Position Control Function (A02B-0334-R400)**  
Axis is shifted from position control to pressure control, to keep programmed pressure. Used with multi-axes high speed response function. Selection between position control and pressure control is made automatically, based on contact. Primary applications in servo die cushion.
- **Position Control Keep Function (-R401)**  
When using Pressure & Position Control function, prevents switching from position to pressure control mode upon input of signal. Prevents unexpected shifting to pressure control.



# 10 unbeatable arguments for controls from FANUC:

1. Maximize machine uptime and minimize TCO with FANUC's world class reliability, delivering MTBF rates in excess of 17 years.
2. Secure investment with a 25-year replacement part availability and support commitment.\*
3. Increase competitive edge with state-of-the-art technologies to increase quality, efficiency, reliability and to reduce cycle times.
4. Minimize training and support costs with continuity of operation and upward compatibility to run existing programs on new CNCs.
5. Reduce delivery times with quick and easy at-the-machine programming.
6. World-class factory-trained service, training as well as free lifetime technical support provide decades of trouble-free operation and the lowest MTTR.
7. Boost efficiency with Ethernet enabled data and remote diagnostics.
8. Minimize downtime by separating CNC and PC technologies.
9. Rely on a world class partner for simple through complex machine tools.
10. Simplify integration with FANUC robots by using the standard interface.

\*When a FANUC CNC system is out of production, we strive to have replacement parts for 25 years. Replacement parts are available for purchase or through extended service contracts. If and when parts are no longer available due to discontinued component manufacturing, we offer repair and reuse. We strive to engineer replacement parts with the same functionality, form and fit. We offer on-site FANUC factory-trained service and support on FANUC CNCs for the lifetime of your machine.



	Power Motion <i>i</i> - MODEL A
Maximum number of controlled axes	32
Maximum number of feed-axes	32
Maximum number of multi-axis, high-response	24
Maximum number of simultaneously interpolated axes	4
Maximum number of controlled program paths	4
Maximum axis controlled by PMC	16
Maximum part program storage	1 MB
Increment System A 0.01 mm, 0.01 degrees, 0.001 inches	•
Increment System B 0.001 mm, 0.001 degrees, 0.0001 inches	•
Increment System C 0.0001 mm, 0.0001 degrees, 0.00001 inches	•2
PMC system	•
Maximum PMC paths (simultaneous program processing)	5
Maximum number of PMC program steps	300,000
PMC processing, ns per step	9.1
PMC Execution Cycles	8, 4, 2, 1 msec
Maximum number of I/O points	4096/4096
PMC axis control	•1, •2
Torque Control (included in PMC Axis Control)	•1, •2
Stand-Alone mount logic rack with 2 expansion slots	•
LCD mount logic rack with 0, 1 or 2 expansion slots	•
Open System	☆
Integrated safety 'Dual Check Safety'	☆
Dual Check Safety Acceptance Test Function	☆
Data communication	RS-232, Ethernet
Field Communication	FL-Net, Safety by FL-Net, DeviceNet, Profibus, CC-Link, Ethernet IP Scanner/Adapter, Modbus-TCP
<b>Standard display</b>	
TFT-LCD color display	8.4", 10.4", 15" LCD
TFT-LCD color display with Touch Panel	10.4", 15" LCD
PCMCIA ports accessible from front bezel	•
USB port for Data I/O accessible from front bezel	•
<b>Display with Windows®</b>	
Processor	Pentium™ M, Celeron™ M, Celeron™
Main Memory	Up to 4GB
Storage capacity	Minimum 500GB HDD or up to a 64GB SSD
Operating system	Windows Embedded OS supplied by FANUC (Windows 7 Professional Supported)
<b>SATA ports</b>	3 Total (1 for SSD card and 2 for general device)
TFT-LCD Color Display	10.4" (800x600), 15" (1024x768) 19" (1280 x 1024)
Keyboard	PC QWERTY or Standard MDI
PCMCIA port accessible from front side	1
USB ports	5 total – 1 front, 4 rear
Serial ports	2
PCI slots	2 (PCI v2.3, 32 bit)
Ethernet port (10BASE-T/100BASE-T/1000BASE-T)	1

- Basic Feature
- 1 Included in Basic Option 1
- 2 Included in Basic Option 2
- ☆ Optional Feature

## Power Motion *i*- MODEL A

iPendant handheld LCD display & panel	☆
Handy Machine Operator Panel	☆
Custom Macro	•1, •2
Addition of Custom Macro Common Variables	•1, •2
Macro Executor	☆
C-language Executor	☆
FANUC Picture	☆
<b>Displays</b>	
Status/program/parameter	•
PMC monitoring and editing	•
Servo and spindle device	•
Alarm/operating archive	•
Support for up to 17 languages	☆
Customer-specific configuration	☆
<b>Control Axis Detach</b>	•2
<b>Inch/Metric Conversion</b>	•2
<b>Manual Handle Feed 1-Unit</b>	•1, •2
<b>Tool Offsets 99 Pairs</b>	•2
<b>Tool Offsets 200 Pairs</b>	☆
<b>Stored Stroke Check</b>	•
<b>Stroke Limit External Setting</b>	•2
<b>Stored Pitch Error Compensation</b>	•2
<b>Straightness Compensation</b>	☆
<b>Linear interpolation/circular interpolation</b>	•
<b>Dwell (seconds)</b>	•
<b>Helical interpolation</b>	☆
<b>Polar coordinate interpolation</b>	☆
<b>Advanced preview control</b>	☆
<b>Advanced Feed Forward Control</b>	•
<b>Automatic Acceleration/Deceleration Rapid:Linear Feed:Exponential/Linear</b>	•
<b>Rapid Traverse Bell-Shaped Acceleration/Deceleration</b>	•
<b>Positioning by Optimum Acceleration</b>	☆
<b>Bell-Shaped Acc/Dec after cutting feed interpolation</b>	☆
<b>Axis synchronous control (up to 16 pairs, includes Tandem Control)</b>	☆
<b>Synchronous Cutting</b>	•2
<b>Skip</b>	•
<b>Torque Skip</b>	•
<b>Multi-Step Skip</b>	•2
<b>High Speed Skip function</b>	☆
<b>Position Switch</b>	•2
<b>High Speed Position Switch</b>	☆
<b>Function of Deceleration Stop in case of Power Failure</b>	•
<b>Linear scale I/F with absolute address reference mark (includes distance coded scales)</b>	☆
<b>Unexpected Disturbance Torque Detect</b>	☆
<b>Multi-Axes High Speed Response Function</b>	☆
<b>Macro for Multi-Axes High Speed Response Function</b>	☆
<b>Skip for Multi-Axes High Speed Response Function</b>	☆
<b>Position Definition Type Synchronous Function</b>	☆
<b>Pressure &amp; Position Control Function</b>	☆
<b>Position Control Keep Function</b>	☆
<b>Function for Press Machine</b>	☆
<b>Robot Connection Function</b>	☆

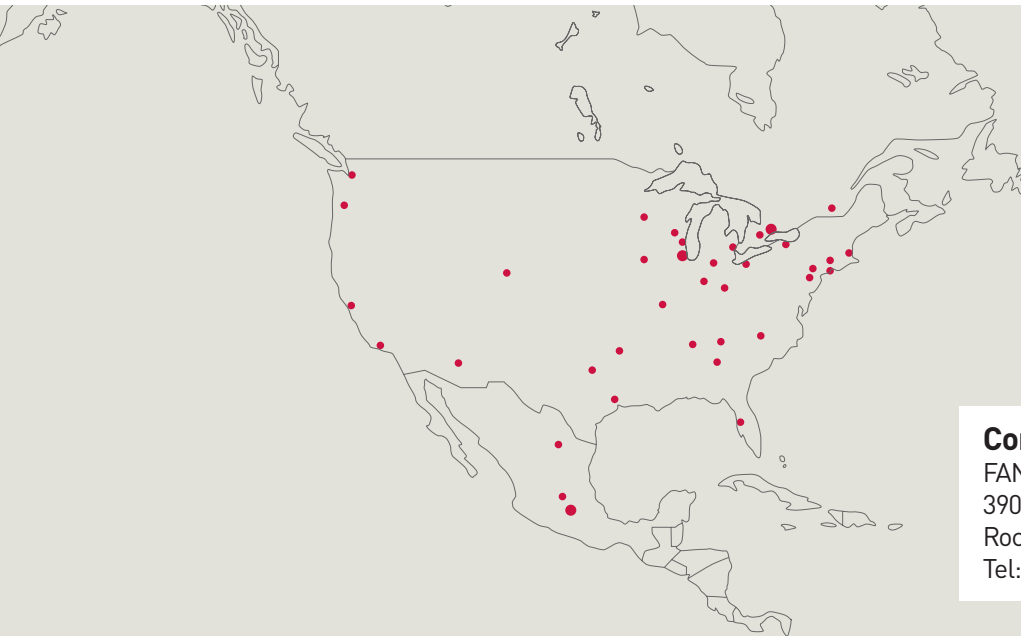

## Corporate Headquarters

FANUC America Corporation  
 3900 W. Hamlin Road  
 Rochester Hills, MI 48309  
 Tel: 888-FANUC-US (888-326-8287)

### United States

FANUC America Corporation  
 FANUC CNC  
 1800 Lakewood Boulevard  
 Hoffman Estates, IL 60192  
 Tel: 888-FANUC-US (888-326-8287)  
 Fax: 847-898-5001  
[cnc.info@fanucamerica.com](mailto:cnc.info@fanucamerica.com)

### Canada

6774-A Financial Dr.  
 Mississauga, ON L5N 7J6  
 Tel: 888-326-8287  
 Fax: 905-812-0053

### Mexico

Av. Gustavo Baz # 2160 Edificio 4 PB  
 Col. Fracc. Ind. La Loma  
 Tlalnepantla, Mexico  
 Tel: 52 555-010-3400  
 Fax: 52 555-010-3410

### Brazil

Rua Otaviano Alves de Lima, 1536  
 São Paulo, SP 02501-000, Brazil  
 Tel: 55 11-3952-8888  
 Fax: 55 11-3856-0848

### Argentina

Av. Juan de Garay 2275/2283  
 C1256AAE Buenos Aires, Argentina  
 Tel: 54 11-4942-8504  
 Fax: 54 11-4942-1319

Appleton, WI  
 Atlanta, GA  
 Boston, MA  
 Charlotte, NC  
 Cincinnati, OH  
 Cleveland, OH  
 Dallas, TX  
 Denver, CO  
 Des Moines, IA  
 Detroit, MI  
 Ft. Wayne, IN  
 Hartford, CT  
 Houston, TX  
 Indianapolis, IN  
 Knoxville, TN  
 Long Island, NY  
 Los Angeles, CA  
 Milwaukee, WI  
 Minneapolis, MN  
 Nashville, TN  
 Philadelphia, PA  
 Phoenix, AZ  
 Pine Brook, NJ  
 Portland, OR  
 Rochester, NY  
 San Francisco, CA  
 Seattle, WA  
 St. Louis, MO  
 Tampa, FL  
 Tulsa, OK

Guelph, ON  
 Montreal, QC

Monterrey  
 Querétaro

Belo Horizonte  
 Caxias do Sul  
 Curitiba  
 Manaus

The products in this catalog may be controlled based on Japan's "Foreign Exchange and Foreign Trade Law". The export from Japan may be subject to an export license from the government of Japan. Additionally, the products also may be controlled by the export or re-export regulations of the United States government or other countries.

If any customer intends to, or shall, export (or re-export), directly or indirectly, any portion of the products, technology or software relating thereto, it is the responsibility of customer to assure compliance with United States and other export control laws and regulations and if appropriate, to secure any required export licenses or approvals in its own name.

Technical data is subject to change without prior notice. No part of this document may be reproduced in any form. All rights reserved.  
 © 2014 FANUC America Corporation



FANUC America Corporation  
[www.fanucamerica.com](http://www.fanucamerica.com)  
 888-FANUC-US (888-326-8287)