

FANUC LR Mate 200*i*D/4S FENCELESS CART (DCS/AB SCANNER)

Shown with optional Multi-Gripper, Battery & Pill PBL kits, and 2D *i*RVision with light kit



Optional Multi End-of-Arm Tooling package and *i*RVision hardware



Features

The NEW FANUC LR Mate 200*i*D/4S FENCELESS CERT Cart was developed from combining FANUC DCS Position and Speed Check software with an Allen Bradley SafeZone Mini Safety Laser Scanner. The result is FANUC's NEW FENCELESS Cart that will still fit through a standard door and runs off 110V power. The FENCELESS cart allows a greater work envelope and introduces students to the latest in integrated safety products from FANUC and Allen Bradley.

- Can accommodate either LR Mate 200*i*D or LR Mate 200*i*D/4S
- 180+ degree work envelope
- Space on worktable for all PBL kits: Including Shapes and optional PBL kits (Battery, Pill, and New Palletizing blocks)
- Part #'s for PBL printed on table top for easy ordering
- NEW Integrated Safety Stack light
- NEW 4.6 Gallon Ultra Quiet Air Compressor
- NEW Easy Rolling all direction locking Casters
- Standard: Gripper Fingers with embedded laser pointer for Shape outlines and other projects
- Optional: Multi End-of-Arm Tooling with suction cups
- Optional: Integrated Robot mounted 2D *i*RVision Camera
- Optional: 2D *i*RVision Light Kit

Safety Specifications

- RIA/ISO10218 Compliant
- Safely monitor the position or speed of the robot and shut down motor power when the defined safety parameters are exceeded
- DCS speed checking zones (slow speed 125mm/sec and zero speed) are OSSD safety rated inputs from the scanner

FANUC Robot LR Mate 200iD

Operating space

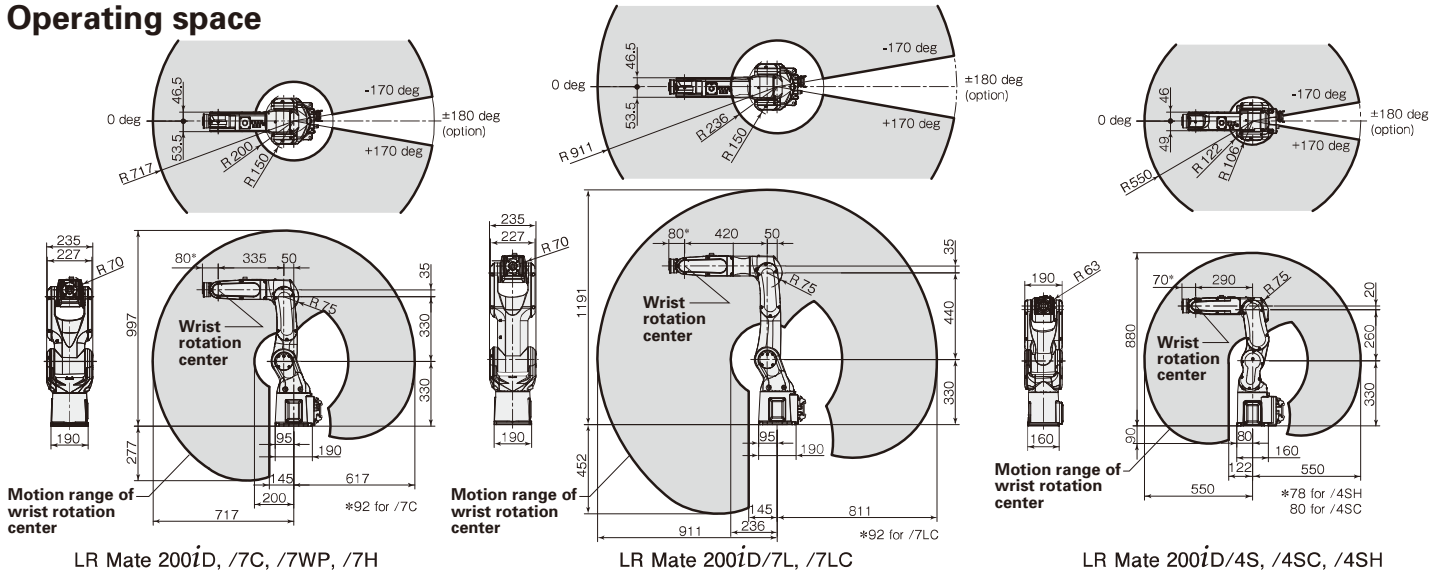

Specifications

Model	LR Mate 200iD LR Mate 200iD/7C LR Mate 200iD/7WP	LR Mate 200iD/7H	LR Mate 200iD/7L LR Mate 200iD/7LC	LR Mate 200iD/4S LR Mate 200iD/4SC	LR Mate 200iD/4SH	
Controlled axes	6 axes	5 axes	6 axes	6 axes	5 axes	
Reach	717 mm		911 mm	550 mm		
Installation (Note 2)	Floor, Upside-down, Angle mount					
Motion range (Maximum speed)	J1 axis	340°/360°(option) (450°/s) 5.93 rad/6.28 rad (option) (7.85 rad/s)	340°/360°(option) (370°/s) 5.93 rad/6.28 rad (option) (6.46 rad/s)	340°/360°(option) (460°/s) 5.93 rad/6.28 rad (option) (8.03 rad/s)		
	J2 axis	245°(380°/s) 4.28 rad (6.63 rad/s)	245°(310°/s) 4.28 rad (5.41 rad/s)	230°(460°/s) 4.01 rad (8.03 rad/s)		
	J3 axis	420°(520°/s) 7.33 rad (9.08 rad/s)	430°(410°/s) 7.50 rad (7.16 rad/s)	402°(520°/s) 7.02 rad (9.08 rad/s)		
	J4 axis	380°(550°/s) 6.63 rad (9.60 rad/s)	250°(545°/s) 4.36 rad (9.51 rad/s)	380°(550°/s) 6.63 rad (9.60 rad/s)	380°(560°/s) 6.63 rad (9.77 rad/s)	240°(560°/s) 4.19 rad (9.77 rad/s)
	J5 axis	250°(545°/s) 4.36 rad (9.51 rad/s)	720°(1500°/s) 12.57 rad (26.18 rad/s)	250°(545°/s) 4.36 rad (9.51 rad/s)	(Note 6) 240°(560°/s) 4.19 rad (9.77 rad/s)	720°(1500°/s) 12.57 rad (26.18 rad/s)
	J6 axis	720°(1000°/s) 12.57 rad (17.45 rad/s)		720°(1000°/s) 12.57 rad (17.45 rad/s)	720°(900°/s) 12.57 rad (15.71 rad/s)	
Max. load capacity at wrist	7 kg			4 kg		
Allowable load moment at wrist	J4 axis	16.6 N·m			8.86 N·m	
	J5 axis	16.6 N·m	4.0 N·m 5.5 N·m (option)	16.6 N·m	8.86 N·m	4.0 N·m 5.5 N·m (option)
	J6 axis	9.4 N·m		9.4 N·m	4.90 N·m	
Allowable load inertia at wrist	J4 axis	0.47 kg·m ²			0.20 kg·m ²	
	J5 axis	0.47 kg·m ²	0.046 kg·m ² 0.15 kg·m ² (option)	0.47 kg·m ²	0.20 kg·m ²	0.046 kg·m ² 0.083 kg·m ² (option)
	J6 axis	0.15 kg·m ²		0.15 kg·m ²	0.067 kg·m ²	
Repeatability	± 0.02 mm		± 0.03 mm	± 0.02 mm		
Mass (Note 3)	25 kg	24 kg	27 kg	20 kg	19 kg	
Installation environment	Ambient temperature : 0~45°C Ambient humidity : Normally 75%RH or less (No dew nor frost allowed) Short term 95%RH or less (within one month) Vibration acceleration : 4.9m/s ² (0.5G) or less					

Note 1) In case of short distance motion, the axis speed may not reach the maximum value stated.

Note 2) Angle mounting needs J1 and J2 axis motion range restriction according with the payload, except for LR Mate 200iD/4S, /4SC and /4SH.

Note 3) Without controller.

Note 4) The liquids that deteriorate the sealing members, such as organic solvents, acids, alkalis, and chloric coolants, must not be used.

Note 5) Cleanliness of the clean type (/7C, /7LC, /4SC) is class 10 (ISO class 4) with white paint, antirust surface and food grade grease.

Note 6) In case of /4SC, J5 motion range is restricted to 236° (4.11rad).

FANUC

FANUC AMERICA CORPORATION
3900 WEST HAMLIN ROAD
ROCHESTER HILLS MI 48309-3253



MARKETING@FANUCAMERICA.COM

FANUCAMERICA.COM 888-FANUC-US