

THE FACTORY AUTOMATION COMPANY

FANUC

ROBODRILL *α-DiB5* series

High-performance vertical machining centre



WWW.FANUC.EU

Automated machining
for more versatile milling,
drilling and tapping

Enter the efficiency zone!

FANUC designs efficiency for your production processes in the form of CNC systems, drives, robots and production machines. All produced in one of the most highly automated factories in the world. Ready to integrate and backed by unrivalled support and service. It's how we give you a competitive edge. **Manufactured Efficiency for productivity to go.**

Efficient products

All FANUC products involve manufactured efficiency. Fewer parts and lean technology make them reliable, predictable and easy to repair. They are made to run and provide you with the highest uptime on the market.

Efficient innovations

Manufactured efficiency is also at the heart of every FANUC innovation. Based on proven FANUC technologies, this is designed to increase the efficiency of your production facilities.

Efficient support and service

FANUC support and service is about manufactured efficiency too. We listen carefully to your needs and deliver on our promises. We also take care of our products as long as they are in service. Personal and responsive, we help you achieve maximum efficiency.

FANUC is the factory automation specialist

We've been automation experts for almost 60 years. With more than 20 million FANUC products operating worldwide – including 420,000 FANUC robots, 3.5 million FANUC CNCs and 16 million FANUC servomotors – we think our track record speaks for itself.*



Versatility beats size. Intelligence beats raw power.

The new-generation ROBODRILL promises unrivalled quality and precision at great hourly rates. With an unbeatable tool change time of 0.7 seconds and a turret capable of handling tools weighing 4 kg, the new advanced version is both the fastest and strongest vertical machining centre on the market. With by far the shortest cycle times on most machining operations, all ROBODRILL machines are real high-speed all-rounders offering incredible performance and unbeatable efficiency.

MANUFACTURED EFFICIENCY

Smart is the new powerful



Using intelligent cutting strategies, ROBODRILL achieves the same results as more powerful machines in less time, regardless of whether your application involves high-speed machining, mould making or 5-axis machining.

MANUFACTURED EFFICIENCY

Future-proof investment



FANUC's legendary reliability coupled with easy preventative maintenance procedures keeps downtime to an absolute minimum. And thanks to their extreme longevity, ROBODRILL machines also provide an unbeatable return on investment.

ultrafast tool changer

very strong turret

highly dynamic BT30 spindle

rigid servo drive control

optimal acceleration and deceleration control

latest CNC and servo technology

extraordinarily stable machining and accuracy

40 years of
ROBODRILL
technology

designed and built in Japan

The multipurpose solution to your efficiency needs

Designed to meet every need, the ROBODRILL α -DiB5 series comprises six completely re-designed models in S, M and L sizes, available in either standard or advanced versions. With a rigid servo drive control and a highly dynamic BT30 spindle, these high-speed all-rounders are suitable for all vertical machining applications, from short production runs requiring fast turnaround times to flawless mass production. With 210,000* machines installed since 1972, its future-proof versatility and easy adaptability make the ROBODRILL the best-selling machine in its class.

ROBODRILL standard version: focus on efficiency

The standard version ROBODRILL α -DiB5 is a fast, high-quality all-rounder. With a number of different spindle options to choose from, it's perfect for standard applications. Excellent repeatability makes this model ideally suited to applications such as high-speed drilling, boring and tapping in the tooling and medical industries.

- **rigid design** and a rugged cast cross table
- **easy maintenance** thanks to direct access to all components
- **easy operation** thanks to quick and simple, intuitive setup options
- **new iHMI** for utmost user-friendliness and full maintenance planning
- **dedicated maintenance screen** – easy instructions ensure quick recovery if, for example, zero points are lost due to incorrect operator input
- **early issue detection** thanks to an integrated early warning system providing enhanced quality assurance
- **70-bar centre through coolant pressure** for non-stop deep and small diameter hole drilling
- **flexibility at any time** thanks to a wide range of components to suit your needs including rotary and tilting tables

ROBODRILL advanced version: extra-strong and superfast

Advanced ROBODRILL α -DiB5 ADV models are designed for cutting-edge high-speed machining and set the performance benchmark in their class. Providing the ultimate in precision and repeatability, they are perfect for long fully automated production runs and represent a versatile alternative to larger machines. Advanced models come with a range of highly advanced features not available on standard models.

Additional advanced model features:

- **0.7-second tool change** for superfast cycle times
- **4-kg tool handling capability** for multistep tools
- **400-mm z-axis latitude** for larger parts and less interference between tools and workpieces



Standard or advanced models are available in S, M and L sizes. **

The secret's in the speed

Tool-on-tool changes on ROBODRILL α -DiB5 models are extremely fast – ranging from 0.9 seconds on our standard versions to an incredible 0.7 on the advanced. Cut to cut that means 1.5 seconds for standard and 1.3 seconds for advanced versions. That's the secret to our speed machine!

MANUFACTURED EFFICIENCY

Improved swarf evacuation



To maximise uptime, the ROBODRILL α -DiB5 series has been fitted with a number of swarf evacuation options: from the coolant tank and chip flush methods to a piping system for wall coolant. Advanced versions minimise swarf interference with a dome-shaped Y-axis front cover. It also offers an optional fully enclosed spindle cover that separates the machining area from the mechanism.

MANUFACTURED EFFICIENCY

Stronger turret for bigger tools



Advanced model ROBODRILLS feature an even stronger turret. Offering even more versatility, this enables the tool changer to handle heavy, customised cutting tools weighing up to 4 kg while still realising ultra-quick tool changing times of 1.1 seconds.

MANUFACTURED EFFICIENCY

The tool changer



At the heart of every ROBODRILL is a patented high-speed tool changer that can carry 21 tools and offers the best reliability in its class. Its manufactured efficiency lies in its solid metal construction and BIG-PLUS BBT30 spindle. This makes it extremely resistant to radial forces and enables it to deliver unbelievably efficient machining.



High-precision control

The world's most reliable CNC FANUC 31i-B5 is at the core of ROBODRILL. User-friendly and easy to program, it contains twenty easy-to-configure M-codes to control additional devices. Further customisation is achievable via the custom PMC function.

CF card

USB

easy-to-clean membrane keyboard

optional integrated 5-axis functions

manual pulse generator



- 10.4" colour display
- intuitive iHMI screen
- easy data input and minimal keypad entry
- improved interface to robot operation screen

- precise predictive maintenance
- easy auto programming
- easy-to-use control screen
- supports multiple languages

- optimised data compatibility
- Ethernet interface
 - USB interface
 - CF card slot

The freedom to adapt

Whether it's a new setup or changing unit numbers, ROBODRILL's inherent versatility saves you money within a wide range of applications and industries. With everything on board from flexible 3, 4 and 5 simultaneous axes, every model has been designed to grow with your needs.

MANUFACTURED EFFICIENCY

The intelligent alternative to big machines



Spreading your machining across several ROBODRILLS instead of relying on a dedicated transfer machine allows you to benefit from cheaper production and higher flexibility in the face of changing production numbers. Inherently adaptable, FANUC ROBODRILL also represents a great supplement to your production facilities since you can use it to absorb extra demand, thereby freeing up your larger vertical machining centres for bigger jobs.

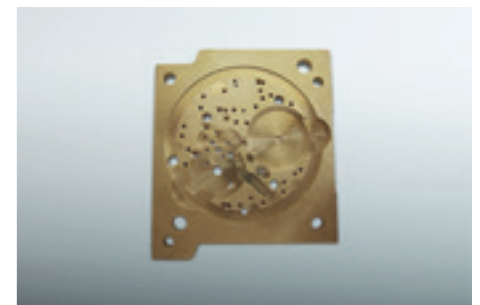
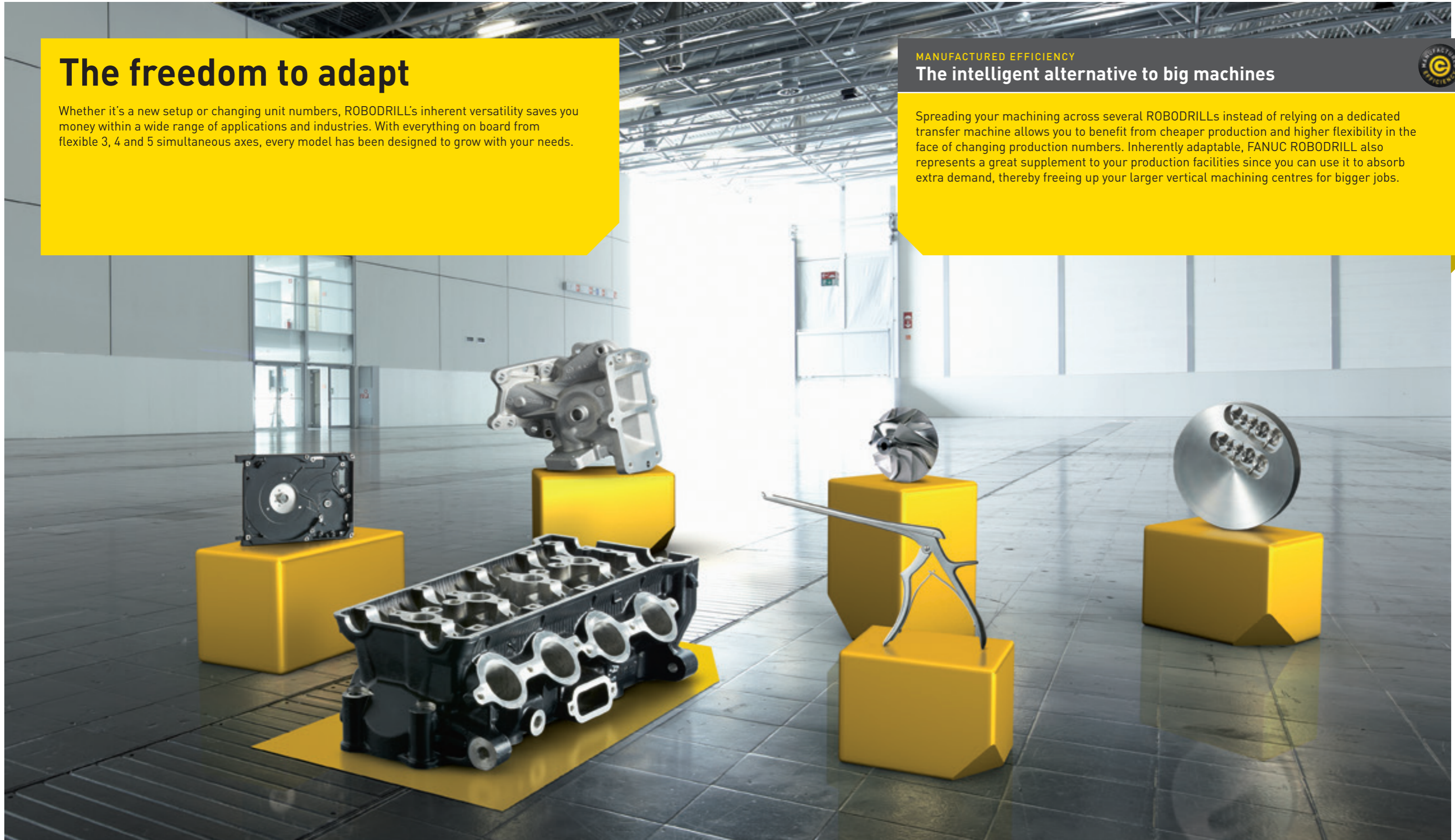

FANUC ROBODRILL for the automotive industry

Mass-producing parts for the automotive industry requires a versatile machining centre that combines speed with repeatable accuracy. It needs to keep on producing flawless parts with a minimum of downtime, accelerate quickly and deliver fast cycle times. To maximise availability and cut costs, it has to be easy to maintain and operate. On-board monitoring should make it fully predictable and ensure that preventative maintenance procedures are always focussed, timely and necessary. Given rapidly changing production runs, it needs to be quick and simple to program and set up. Doing all of this and more, ROBODRILL is ideally suited to automotive applications.

Adding fixtures

For more flexible fixture integration, the control panel is available with 220 optional PMC functions and can be customised to include dedicated buttons and lights. An additional PMC function allows operators to create their own I/O options. To ensure maximum uptime, clamping fixtures are secured automatically and the process is confirmed by sensors.

Easy automation

Thanks to a direct robot interface – for 24-h unmanned production, lower costs, easy CNC operation and communication via multiple interfaces, including PROFIBUS and FL-net.

Lower cycle times

Optimise your programs and reduce your cycle times using the latest CNC and servo control technologies such as FSSB high-speed rigid tapping, smart overlap and control time reduction.

Stable process

Measurement cycle and tool management functionality provide efficient tool monitoring for even more stable processes – absolutely reliable tool changer for seamless working in the most stable processes.



FANUC ROBODRILL for the electrical and watch industry

Electrical and watch industry applications often require tiny holes to be drilled in precision components such as disk enclosures and watch plates. To do this, ROBODRILL comes with a finely balanced spindle to ensure a very high degree of repeatable accuracy. To maximise precision on applications of this kind, ROBODRILL also includes a tool cleaning unit. Cleaning both the tool and spindle during tool changes, this feature vastly improves repeatability.

High-speed spindle

Delivering maximum precision, speed and stability, ROBODRILL's high-speed spindle is perfectly suited to the very small diameter tools used in the electrical and watch industries. Equipped with 70-bar through-spindle coolant for faster drilling and improved swarf removal, it also supports special drilling and tapping cycles for improved productivity.

HRV+ Servo Control

The HRV+ Servo Control uses high-resolution encoders and spindle control to deliver the kind of 'nano'-level surface quality demanded by the electrical and watch industries. Using smooth acceleration and deceleration to minimise axis-overshoot errors, it also decreases part-form tolerances by suppressing acceleration/deceleration delays and servo lag.

Precise drilling and tapping

On applications involving small diameter holes, peck drilling cycles and FANUC Learning Control reduce cycle times and ensure flawless continuous production.



FANUC ROBODRILL for the medical industry

Despite their complexity, medical equipment and implants often require finishing to extremely high standards. ROBODRILL comes with a number of different features designed to drastically reduce cycle times and make achieving these perfect surfaces easy. These include 5-axis functionality such as High-Speed Smooth TCP (a feature that radically improves surface quality by compensating for tool direction to avoid stripes), Tool Centre Point Control (TCP) and Tilted Working Plane.

High-speed spindle

Delivering maximum precision, speed and stability, ROBODRILL's high-speed spindle is perfectly suited to the very small diameter tools used in the medical industry. Equipped with 70-bar through-spindle coolant for faster drilling and improved swarf removal, it also supports special drilling and tapping cycles for improved productivity.

Rigid machining

Machining very hard materials often used in the medical industry, such as stainless steel and titanium, to high degrees of accuracy requires a rigid machining centre. ROBODRILL's surface table provides the enhanced rigidity this kind of machining demands – something that not only translates into maximum precision but also increased tool life.

5-axis functions (TCP/TWP)

Ideally suited to 5-axis machining operations involving two rotary axes that turn the workpiece, Smooth Tool Centre Point (TCP) provides easier programming, improved cycle time and improved quality of surface finish. This is achieved by correcting the tool orientation and smoothing the program positions. For '3+2'-axis machining, the Tilted Working Plane (TWP) function offers easy and rapid programming setup. When defining the Tilted Working Plane, an input guidance screen provides visualisation to support the operator while requesting the required data in a dialogue.



FANUC ROBODRILL for the tool making industry

Tool making necessitates high machining stability over extended periods. At the same time it's about accuracy and surface quality. FANUC ROBODRILL provides the perfect combination of high-speed precision machining and accurate, repeatable positioning. This makes it the ideal solution for high-volume applications in the mould and tool making industries. Precision is further enhanced by intelligent functions such as Nano Smoothing, High-Speed Smooth TCP or Servo Compensation.

Smoothing function

Machining functions on the FANUC CNC such as Artificial Intelligence Contour Control (AICC) and Nano Smoothing create perfectly smooth surfaces and eliminate the need for manual finishing processes on some applications. Likewise, AI Contour Control I/II enables high-precision machining at optimal machining speeds, eliminating errors, increasing feed rates and achieving perfect surfaces.

ATA Data server

Up to 4 GBs of storage for CAD/CAM programs. Files are easily transferable from a host computer to the Data Server, with part programs for multiple machines manageable from a single location, making it ideal for storing programs.

High-power machining

For heavy-duty machining operations that produce lots of swarf, such as machining moulds from hard steel blocks, a high-power version of ROBODRILL is available. Equipped with a strong spindle, rigid machine structure and excellent chip discharge, this version is also available with options to flush swarf from the wall – something that greatly extends its maintenance cycle.

HRV+ Servo Control

The HRV+ Servo Control uses high-resolution encoders and spindle control to deliver the kind of 'nano'-level surface quality demanded by the tool making industry. Using smooth acceleration and deceleration to minimise axis-overshoot errors, it also decreases part-form tolerances by suppressing acceleration/deceleration delays and servo lag.





Versatile 5-axis machining

To turn your ROBODRILL into a 5-axis machine, all you need to do is add the hardware. Simultaneous 5-axis control and CNC-related requirements such as indexing and simultaneous operation are already in the CNC. Intelligent options such as look-ahead data sets, interpolation and smart smoothing functions mean you can manufacture top-quality moulds, electrodes and other 3D parts quickly and precisely. That's manufactured efficiency.

Heavy-duty machining

ROBODRILL isn't just for small parts. Thanks to ROBODRILL's strong spindle and rigid structure, it is also ideally suited to heavy-duty machining applications, including high-speed operations involving lots of swarf. ROBODRILL even takes large diameter tools normally only found on bigger machines.



FANUC ROBODRILL DDRiB rotary table – the ideal add-on axis

Thanks to its direct drive motor and improved rigidity for more accurate machining, the FANUC ROBODRILL DDRiB makes the perfect additional axis for your ROBODRILL. Benefits include an indexing time of just 0.55 seconds, ultrafast clamping and a clamp torque of 700 N-m. Extremely precise and reliable, the DDRiB also offers unbeatable value for money.

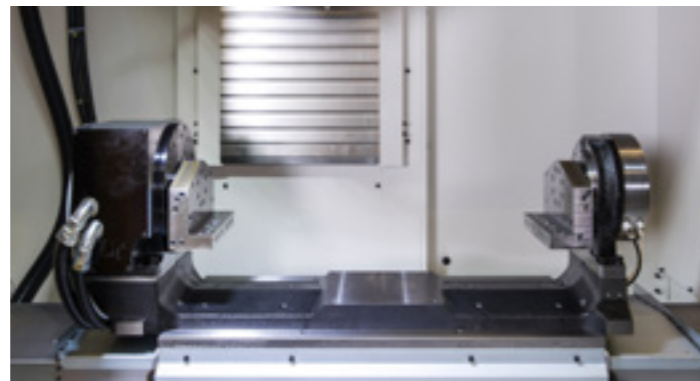

FANUC ROBODRILL DDR-TiB – the solution for parts up to 200 kg

Depending on the application, we can equip your ROBODRILL with an extremely rigid DDR-T trunnion system that features all the benefits of the DDR rotary table and includes a support spindle and L-brackets. Its improved rigidity ensures even higher degrees of machining accuracy. All you need to do is add the fixture plate. The DDR-T's practical design ensures that the existing X-axis travel remains the same as on the 3-axis design. Clamp torque on the DDR-TiB is 1100 N-m.

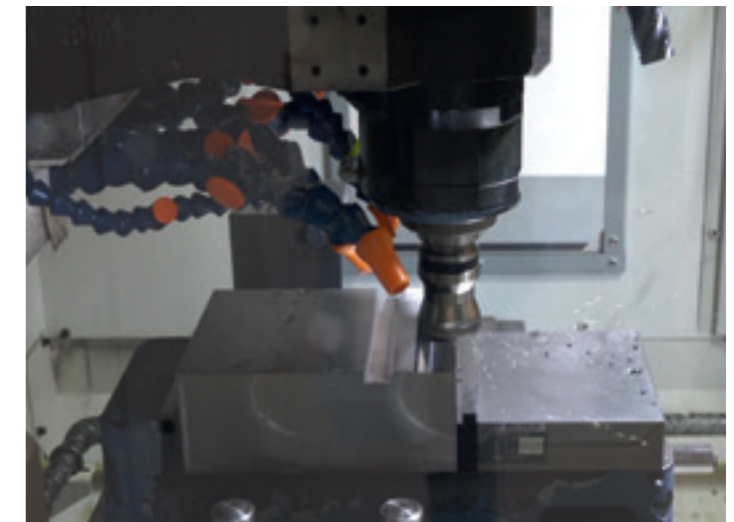
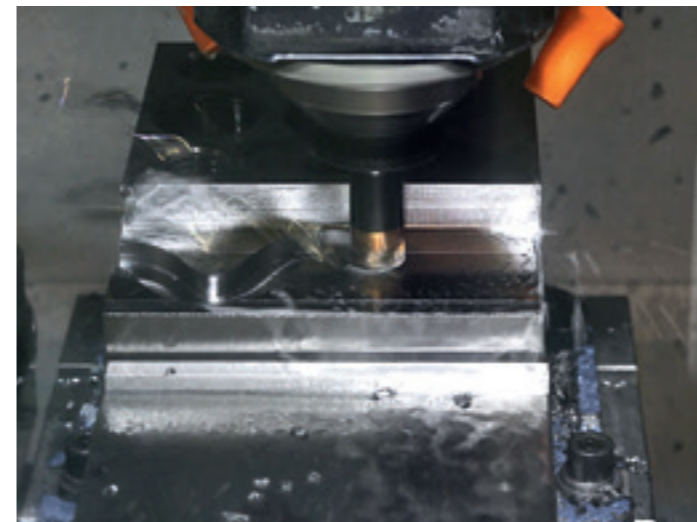

Machining Capability					
Spindle Specification		High-torque spindle		High-acceleration spindle High-speed spindle	
Machining		Drilling Tool dia. (mm) × Feed (mm/rev)	Tapping Tool dia. (mm) × Feed (mm/rev)	Drilling Tool dia. (mm) × Feed (mm/rev)	Tapping Tool dia. (mm) × Feed (mm/rev)
Material	Carbon Steel C45	Dia.30 × 0.15	M20 × 2.5	Dia.20 × 0.10	M16 × 2.0
	Grey Cast Iron	Dia.30 × 0.30	M27 × 3.0	Dia.20 × 0.25	M22 × 2.5
	Die Cast Aluminium Alloy	Dia.32 × 0.40	M30 × 3.5	Dia.22 × 0.25	M24 × 3.0



Remote monitoring with ROBODRILL-LINK*i*

Equipped with a new graphic interface, LINK*i* is an updated production and quality information management tool that allows you to monitor machine status as well as operation conditions of up to 100 ROBODRILL machines in real time from remote PCs or smart devices. Specific information is available for each machining job, and push notifications can be sent to different devices. The extremely user-friendly and intuitive interface gives you access to preventative maintenance functions as well as consumable and repair services.

Status monitor

- layout monitoring
- device monitoring/
device detail monitoring

Operation results

- group operation results
- machining results

Diagnosis

- alarm history
- program history



Major energy savings

FANUC ROBODRILL delivers considerable energy savings compared to its larger rivals. In addition to numerous intelligent features designed to reduce energy consumption, every component has been chosen to provide the highest possible performance for the least possible energy. Power used by the servo, spindle and peripheral devices is calculated by software and displayed on the Energy Saving Screen, enabling you to monitor and optimise power consumption.



Maximum uptime

Simple maintenance – early detection: the intuitive visual maintenance interface on ROBODRILL's 31*i*-B5 CNC facilitates faster recoveries after servicing. The integrated early warning system identifies errors before they occur, ensuring maximum precision and consistent quality standards.

Your efficiency benefits



- easy all-round access for robots
- Quick & Simple Startup Packages with tending robots
- high-speed automatic front and side doors that open in just 0.8 seconds
- versatile interfaces



Designed for easy automation

ROBODRILL's compact design and easy accessibility from all sides make it ideally suited to trouble-free machine tending. Adding tending robots is easy thanks to our Quick & Simple Startup Packages. All FANUC products speak the same language and share a common servo and control platform – something that makes learning and operation extremely easy. For more demanding automation scenarios, FANUC's comprehensive network of dedicated European partners possesses the know-how and technical expertise you need to create the ideal solution for your production facility – no matter what your application or industry.

Standard functions



MANUAL GUIDE i

Designed to reduce the total time it takes you to get a drawing into production, FANUC MANUAL GUIDE i features an ergonomic Graphical User Interface (GUI) and user-friendly icons. Users also benefit from assisted and conversational programming of machining cycles, easy parts programming and simulation.



Quick Screen

To save you time, ROBODRILL's control panel includes four Quick Screens for fast programming and maintenance. These comprise screens for:

- quick CNC program editing
- coordinates and tool compensation settings – including the ability to protect and restore data
- machine operation settings – including machining and energy modes according to program
- maintenance settings – including turret restoration and motor referencing

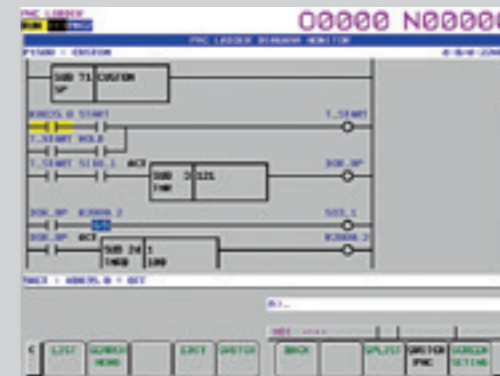

Custom PMC

ROBODRILL's custom PMC features easy-to-create LADDER programs for peripheral devices, including the ability to set LADDER program I/O and customise I/O signals. Its custom control panel includes the ability to monitor the status of peripheral devices, control the ON/OFF on machining programs, create ON/OFF, lamp and pulse switches. Using the panel, peripheral devices are easy and inexpensive to construct and maintain.

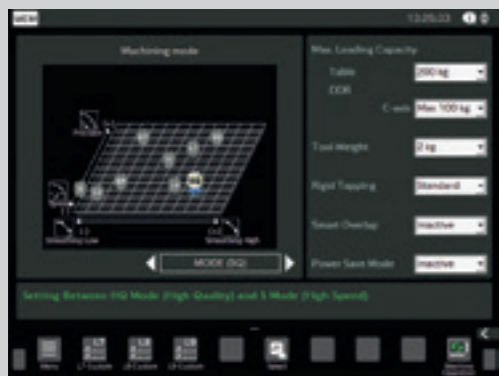

Machining Mode Setting Function

Using this feature, it is possible to set and optimise machining and energy modes according to the program. Servo parameters can be altered to suit machining conditions and machining mode parameters changed via M-code during machining in order to create the best possible conditions for process.



Preventive Maintenance Guidance

Offering a complete overview of ROBODRILL's leakage detection functionality, ROBODRILL's maintenance guidance screens flag up insulation resistance and power leakage issues early, thus avoiding breakdowns by indicating the need for preventative maintenance. Likewise, the screens support periodical maintenance through schedules and reminders. These processes can also be easily customised to suit your exact needs.



AI Thermal Displacement Compensation

Easy to set up, this function significantly reduces machine warm-up times and ensures accurate machining under thermal growth conditions that can affect dimensional accuracy. By monitoring the operational status of the spindle, the function adjusts the machining process to compensate for any elongation that occurs.

List of standard functions

1. new iHMI
2. 10K high-torque spindle
3. basic top cover
4. LED interior lighting
5. automatic oil lubricating
6. Dual Check Safety (DCS)
7. 10.4" colour LCD dynamic graphic display
8. multiple language selection
9. alphanumeric operator's panel
10. manual pulse generator
11. data I/O interface (USB, PCMCIA, Ethernet)
12. Quick Screen (ROBODRILL HMI)
13. preventive maintenance guidance
14. external I/O function (free I/O terminal DI16/DO16, 20 free M-codes)
15. custom PMC LADDER function
16. custom operator's panel function
17. production counter
18. Quick Editor
19. AI thermal displacement compensation (X/Y/Z axis)
20. machining mode setting function
21. energy saving function
22. MANUAL GUIDE i
23. program simulation
24. background editing
25. canned cycles for drilling
26. FSSB high-speed rigid tapping
27. spindle orientation (M19)
28. sub program call (M98[M198]/M99)
29. custom macro
30. optional block skip
31. high-speed skip
32. AI Contour Control
33. helical interpolation
34. coordinate system rotation (G68)
35. part program storage size 512 KB (optional up to 8 MB)
36. number of registrable programs 1000 (optional up to 4000)
37. addition of workpiece coordinate system 48 pairs (optional up to 300)
38. tool offset memory C
39. HRV+ Servo Control
40. rapid traverse overlap function

Optional functions

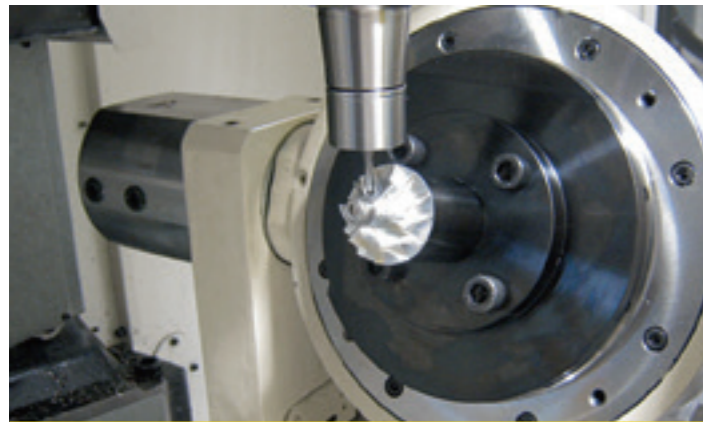

Additional axis interface (4/5 axes)

The standard 31i-B5 CNC already contains the functionality required to turn ROBODRILL into a 5-axis machine. All you need to add is the hardware and software option. Simultaneous 5-axis control capability is already in the CNC. Various third-party rotary tables can also be easily fitted to ROBODRILL using an additional servo amplifier and cable connector. On applications involving rotary tables, FANUC Tilted Working Plane Indexing also makes programming holes and pockets in tilted planes extremely easy.



Robot Interface 2

FANUC's Robot Interface 2 enables easy and inexpensive construction of a machining cell with safety issue. You can easily connect four ROBODRILLS and one ROBOT without an additional system controller – the complete control software is included in the ROBODRILL PMC. In addition, the robot controller supports an automatic side door or an automatic front door.



AI Tool Monitor

The AI Tool Monitor function monitors the load on a spindle during hole machining and, to prevent breakages, issues an alarm should load parameters be exceeded. Designed to prevent breakages and costly downtime from occurring, if a breakage does occur, this feature stops the machine automatically.



Smoothing functions

FANUC ROBODRILL's Nano Smoothing functionality reduces the need for manual finishing on processes, such as mould machining, that require sculptured surfaces. Look-ahead blocks expansion enables higher-precision machining on processes, such as die and mould machining, that involve cutting complex part forms defined by numerous tiny program blocks. AI Contour Control I/II enables high-precision machining at optimal machining speeds, eliminating errors and increasing feed rates.



Touch probe system

For the exact measurement of tools and workpieces as well as contract-free tool breakage monitoring, ROBODRILL can be equipped with state-of-the-art touch probes and tool measurement devices from a third party.



Network interfaces

Networking ROBODRILL with personal computers and robots is achieved easily via Ethernet. ROBODRILL supports various types of field networks and connections such as I/O Link, PROFIBUS-DP and FL-net.

List of optional functions

1. 10K high-acceleration spindle/ 24K high-speed spindle
2. 70-bar centre through coolant
3. tooling system BIG-PLUS (BBT30)/DIN (SK30)
4. High Column (up to +300 mm)
5. additional axis interface (4 axes/5 axes)
6. direct drive rotary table DDR/DDR-T
7. various coolant options (chip flush/CT coolant/tool taper cleaning)
8. automatic front door and/or side door
9. wide opening front door (M: 730 mm/L: 1100 mm)
10. side window of splashguard (CE Lattice window)
11. chip flush improvement covers
12. fully closed top cover
13. automatic lubrication
14. signal lamp
15. tool run-out detection function
16. AI Tool Monitor
17. touch probe system (Renishaw/BLUM)
18. Robot Interface 2 function
19. network interface (Fast Ethernet, FL-net, PROFIBUS, Devicenet, I/O Link etc.)
20. various additional I/O modules for custom PMC function
21. Fast Data Server 2 GB or 4 GB
22. AI Contour Control II
23. high-speed processing and look-ahead blocks expansion (1000 blocks)
24. Nano Smoothing/Nano Smoothing 2
25. Tool Centre Point Control (TCP/High-speed Smooth TCP)
26. 3D cutter compensation
27. 3D coordinate system conversion
28. Tilted Working Plane Indexing command
29. rotary table dynamic fixture offset
30. NURBS Interpolation
31. conical/spiral interpolation
32. cylindrical interpolation
33. Polar Coordinate Command
34. tool position offset/scaling/programmable mirror image
35. single-direction positioning
36. small-hole peck drilling cycle
37. learning control for parts cutting
38. tool management function for ROBODRILL
39. power failure backup module
40. more FANUC CNC hardware/software functions on request

Technical data standard models

α - D21SiB5

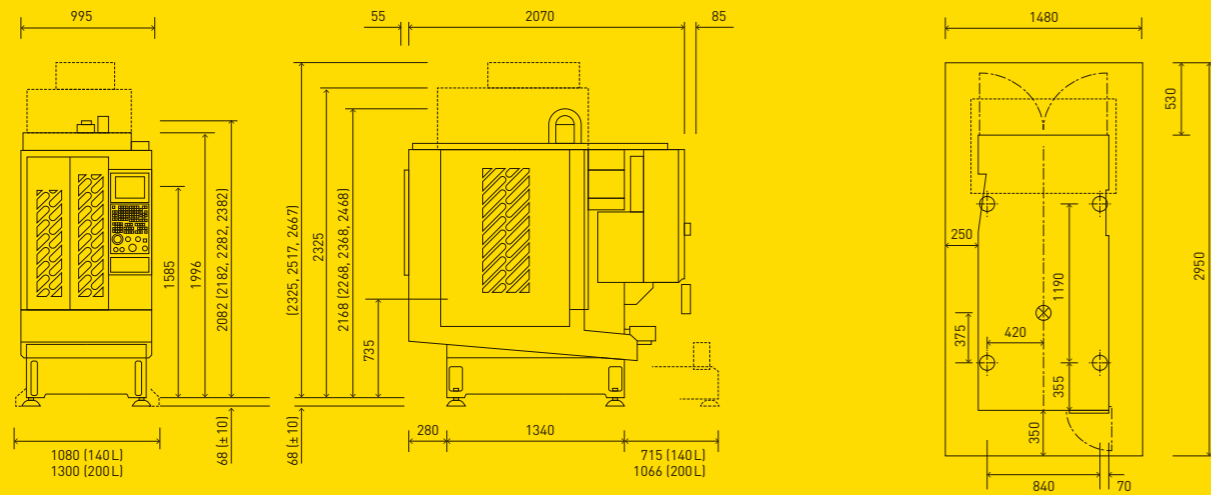

α - D21MiB5

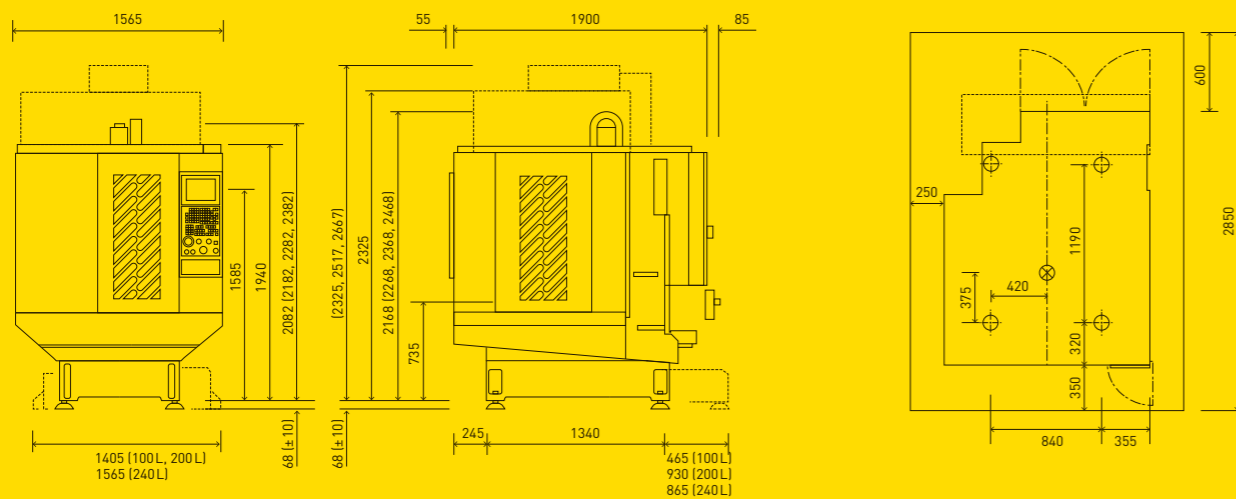

α - D21LiB5

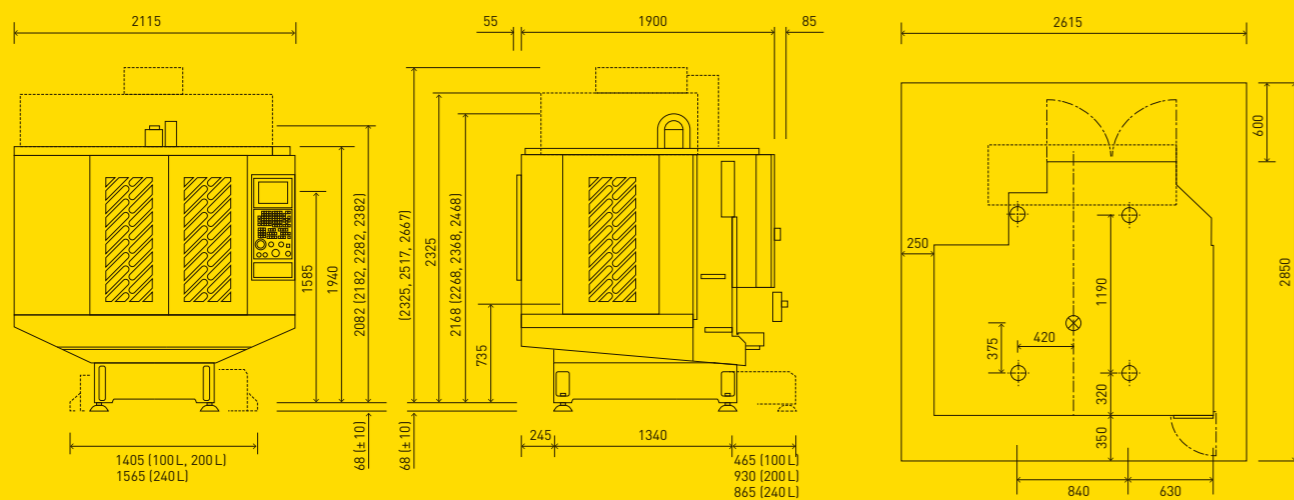

ROBODRILL α - DiB series		α - D21SiB5	α - D21MiB5	α - D21LiB5
Travel X/Y/Z	mm	300 x 300 (+100) x 330	500 x 400 x 330	700 x 400 x 330
Max. tool length (0–24,000 rpm)	mm	190	250	250
Table size	mm	630 x 330	650 x 400	850 x 410
Max. table load	kg	200	300	
Max. tool weight (0–24,000 rpm)	kg	3		
Distance from spindle nose to table (with HC100)	mm	250-580		
Controller		31i-B5		
Spindle speed	rpm	10000 24000		
Spindle load 10,000 rpm (1 min)	Nm kW	80 14.2		
Spindle load 10,000 rpm (continuous operation)	Nm kW	13.6 4		
Spindle load 24,000 rpm (1 min)	Nm kW	35 26		
Spindle load 24,000 rpm (continuous operation)	Nm kW	7.5 5.5		
Rapid traverse in all axes	m/min	54		
Acceleration X/Y/Z [G] (100kg table load, 2kg-tool)		1.6/1.2/1.6		1.4/1.0/1.6
Number of tools		21		
Tool change time (2 kg-tool) (cut to cut)	s	1,6		
Thread cutting 10,000 rpm	rpm	6000		
Thread cutting 24,000 rpm	rpm	8000		
Programmable cutting feed	mm/min	30000		
Spindle holder BT30/SK30 DIN 69871A		●		
Spindle holder BBT30		○		
Positioning accuracy ISO 230-2	mm	0,006		
Repeatability ISO 230-2	mm	+/- 0.002		
Air pressure consumption	L/min Mpa	150 0.35–0.55		
Machine weight/with DDR-T		1.9/2.1	2/2.2	2.1/2.3
Max. tool diameter	mm	80		

Spindle output
10,000 min⁻¹ (high torque)

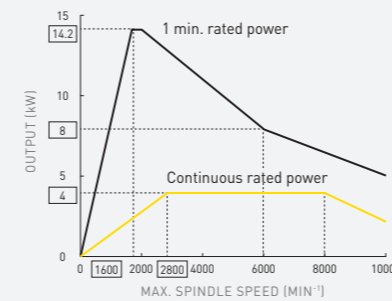

Spindle output
10,000 min⁻¹ (high acceleration)

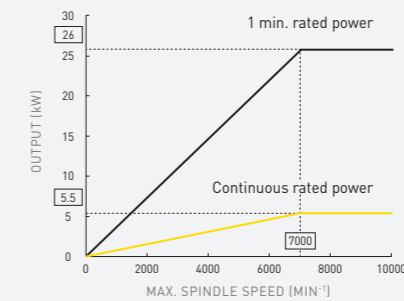

Spindle output
24,000 min⁻¹ (high speed)

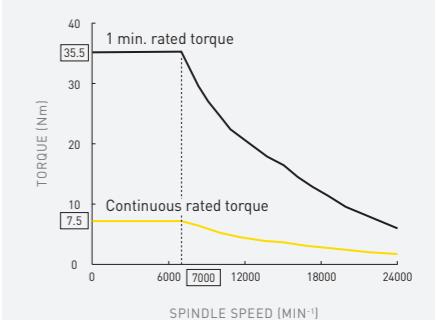
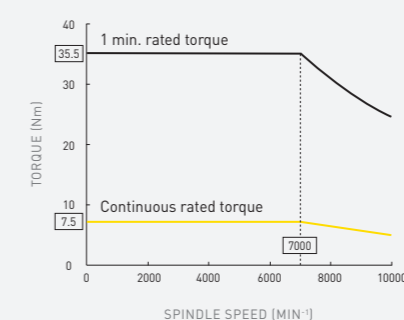
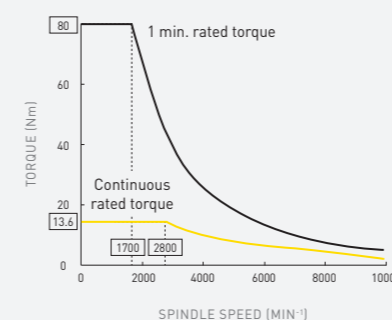
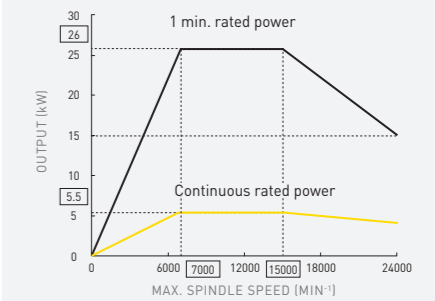

Technical data advanced models

ROBODRILL α -DiB _{ADV} series		α -D21SiB5 _{ADV}	α -D21MiB5 _{ADV}	α -D21LiB5 _{ADV}
Travel X/Y/Z	mm	300 x 300 (+100) x 400	500 x 400 x 400	700 x 400 x 400
Max. tool length (0-24,000 rpm)	mm	190	250	
Table size	mm	630 x 330	650 x 400	850 x 410
Max. table load	kg	200	300	
Max. tool weight (0-24,000 rpm)	kg		4	
Distance from spindle nose to table (with HC100)	mm		180-580	
Controller			31i-B5	
Spindle speed	rpm		10000 24000	
Spindle load 10,000 rpm (1 min)	Nm kW		80 14.2	
Spindle load 10,000 rpm (continuous operation)	Nm kW		13.6 4	
Spindle load 24,000 rpm (1 min)	Nm kW		35 26	
Spindle load 24,000 rpm (continuous operation)	Nm kW		7.5 5.5	
Rapid traverse in all axes	m/min		54	
Acceleration X/Y/Z [G] (100kg table load, 2kg-tool)		1.6/1.2/1.6		1.4/1.0/1.6
Number of tools			21	
Tool change time (2 kg-tool) (cut to cut)	s		1,3	
Thread cutting 10,000 rpm	rpm		6000	
Thread cutting 24,000 rpm	rpm		8000	
Programmable cutting feed	mm/min		30000	
Spindle holder BT30/SK30 DIN 69871A			●	
Spindle holder BBT30			○	
Positioning accuracy ISO 230-2	mm		0,006	
Repeatability ISO 230-2	mm		+/- 0.002	
Air pressure consumption	L/min Mpa		150 0.35-0.55	
Machine weight/with DDR-T		1.9/2.1	2/2.2	2.1/2.3
Max. tool diameter	mm		80	

● Available ○ Optional

DDRiB



DDR-TiB

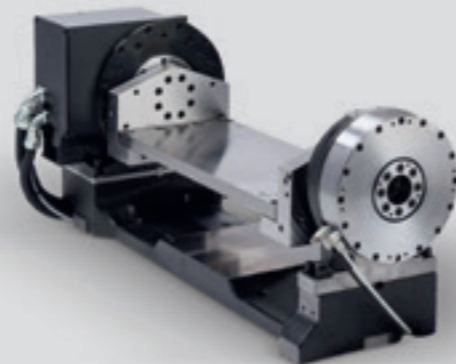

The swing plate is not included.

Technical tables DDRiB/DDR-TiB

FANUC ROBODRILL DDRiB rotary table	Specifications
Drive method	Direct drive
Maximum torque	260 Nm
Table rotation speed	200 min ⁻¹ 300 min ⁻¹ (25 kg, 0.25 kgm ²)
Detector	Absolute AlphaiCZ sensor 512A
Least input increment	0.0001 degrees (IS-C)
Indexing precision	±0.0028 degrees (±10 s)
Clamp method	Air pressure + spring
Clamp torque	700 Nm for air pressure of 0.5 MPa
	450 Nm for air pressure of 0.35 MPa
	100 Nm when air pressure is shut off
Permissible workpiece inertia [kgm ²]	J = 0.99 kgm ² (GD2 = 3.99 kgm ²)
Spindle outside diameter	Ø 90 mm
	Ø 140 mm when the end plate (option) is mounted
Spindle hole diameter	Ø 46 mm
	Ø 55 mm when the end plate (option) is mounted
Center height	150 mm
Main body weight	80 kg
Maximum loading capacity	100 kg
Permissible moment load	F x L = 600 Nm

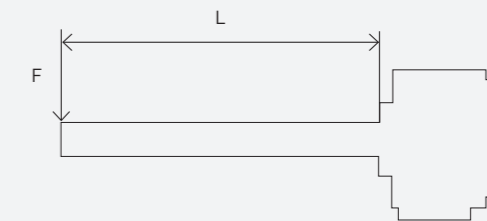

FANUC ROBODRILL DDR-TiB	X300	X500	X700
Clamp torque	1100 Nm (for an air pressure of 0.5 MPa)		
Turning radius	φ 310 mm		φ 410 mm
Number of bracket ports (option)		6 (oil/air)	
Maximum loading capacity	45 kg		150 kg
Center height	200 mm		260 mm
Main body weight	155 kg	190 kg	200 kg

Efficient FANUC service worldwide

Wherever you need us, our comprehensive FANUC network provides sales, support and customer service all around the world. That way, you can be sure you have always got a local contact that speaks your language.

Efficient long-time productivity: FANUC Maintenance Services

To minimise impact on production and get the most out of your machine, we offer maintenance services designed to lower your machine's TCO. Whatever your production scenario, FANUC solutions keep your machine running via dedicated preventive, predictive and reactive maintenance procedures that maximise uptime and keep downtime to a bare minimum.

Efficient training: FANUC Academy

The FANUC Academy offers everything you need to upskill your teams and increase productivity – from introductory programs for beginners through to courses tailored to the needs of expert users and specific applications. Fast and effective learning, on-site training or cross machine training make up the extensive educational offering.

Efficient supply: Lifetime OEM spare parts

As long as your machine is in service, we will provide you with original spare parts – for a minimum of 25 years. With more than 20 parts centres all over Europe, dedicated service engineers and direct online access to FANUC stores, availability checks and ordering, we keep you running whatever happens.

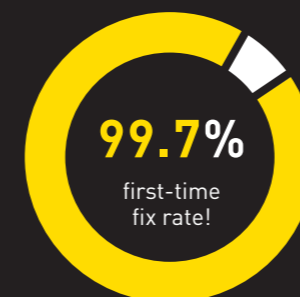

24/7
support



WWW.FANUC.EU/SERVICE



MANUFACTURED EFFICIENCY: 5 PRODUCT GROUPS - ONE COMMON SERVO AND CONTROL PLATFORM



ROBOTS



CNC SYSTEMS
Controls, Drive systems,
Laser systems



ROBODRILL
CNC machining centre



ROBOCUT
Fully CNC controlled
wire EDM machine

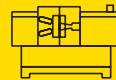

ROBOSHOT
Electric CNC injection
moulding machine



WWW.FANUC.EU